



(12) **United States Patent**  
**Shuster**

(10) **Patent No.:** **US 9,002,820 B2**  
(45) **Date of Patent:** **Apr. 7, 2015**

(54) **FORUM SEARCH WITH TIME-DEPENDENT ACTIVITY WEIGHTING**

(76) Inventor: **Gary Stephen Shuster**, Fresno, CA (US)

(\* ) Notice: Subject to any disclaimer, the term of this patent is extended or adjusted under 35 U.S.C. 154(b) by 368 days.

(21) Appl. No.: **12/479,171**

(22) Filed: **Jun. 5, 2009**

(65) **Prior Publication Data**

US 2009/0307196 A1 Dec. 10, 2009

**Related U.S. Application Data**

(60) Provisional application No. 61/059,210, filed on Jun. 5, 2008.

(51) **Int. Cl.**  
**G06F 17/30** (2006.01)

(52) **U.S. Cl.**  
CPC ..... **G06F 17/30867** (2013.01)

(58) **Field of Classification Search**  
None  
See application file for complete search history.

(56) **References Cited**

**U.S. PATENT DOCUMENTS**

7,860,898	B1 *	12/2010	Moranta et al.	707/803
2002/0052919	A1 *	5/2002	Morris et al.	709/205
2002/0062368	A1 *	5/2002	Holtzman et al.	709/224
2003/0014400	A1 *	1/2003	Siegel	707/3
2003/0055711	A1 *	3/2003	Doherty	705/10
2004/0260781	A1	12/2004	Shostack et al.	
2006/0026147	A1	2/2006	Cone et al.	

2006/0042483	A1	3/2006	Work et al.	
2007/0162432	A1	7/2007	Armstrong et al.	
2007/0208940	A1	9/2007	Adelman et al.	
2007/0218900	A1 *	9/2007	Abhyanker	455/435.1
2007/0226205	A1 *	9/2007	Carrer et al.	707/5
2007/0245245	A1	10/2007	Blue et al.	
2007/0250483	A1	10/2007	Blue et al.	
2008/0033815	A1 *	2/2008	Choi	705/14
2008/0040475	A1	2/2008	Bosworth et al.	
2008/0059458	A1	3/2008	Byron	
2008/0133495	A1	6/2008	Fischer	
2008/0134053	A1	6/2008	Fischer	
2008/0244438	A1 *	10/2008	Peters et al.	715/772
2009/0063260	A1 *	3/2009	Hibbets	705/14
2009/0178125	A1 *	7/2009	Barber et al.	726/6
2009/0248686	A1 *	10/2009	Ponnappan et al.	707/6
2009/0307213	A1 *	12/2009	Deng et al.	707/5
2010/0217722	A1 *	8/2010	Flinn et al.	705/319

\* cited by examiner

Primary Examiner — Bai D. Vu

(74) *Attorney, Agent, or Firm* — Jonathan Jaech; Snell & Wilmer L.L.P.

(57) **ABSTRACT**

A search engine index measures and tracks one or more numeric indicators of activity at different times, including a most current time, in on-line forums and social networking sites. Such indicators may include, for example, a current volume per unit time of messages or data posted to the site, a moving average of such volume, a moving average of current participants over time, a count of current participants, other indication of site activity, or any combination of such indicators. The search engine is responsive to queries seeking forums ranked by activity for a defined time period, including a most current time. The search engine prioritizes search results to identify the specified sites or locations in order of activity (among other possible criteria) relative to a defined time.

**20 Claims, 3 Drawing Sheets**

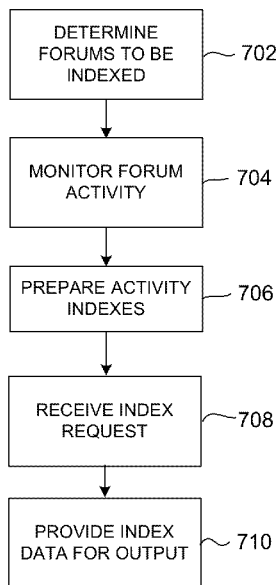

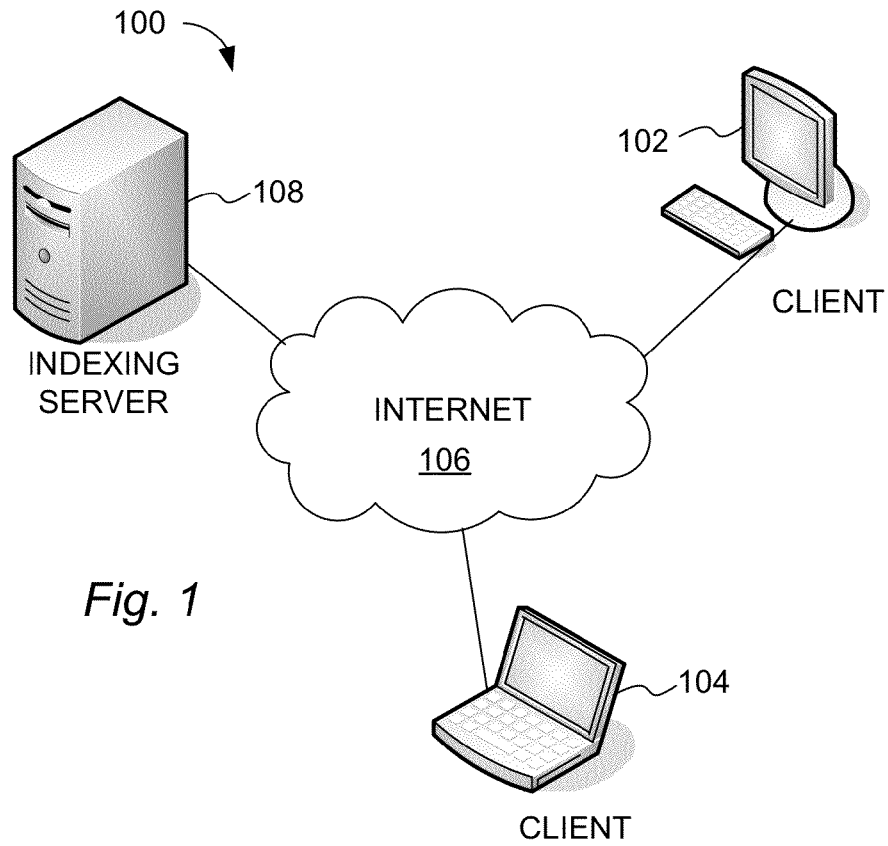

Fig. 1

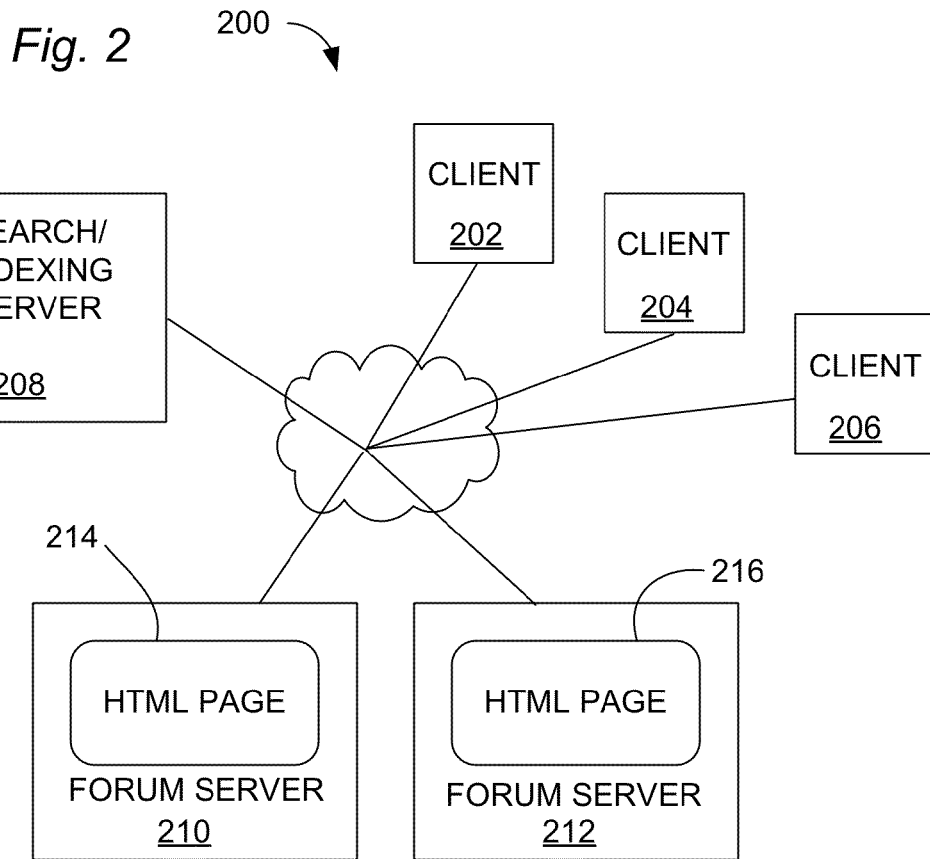

Fig. 2

Fig. 3

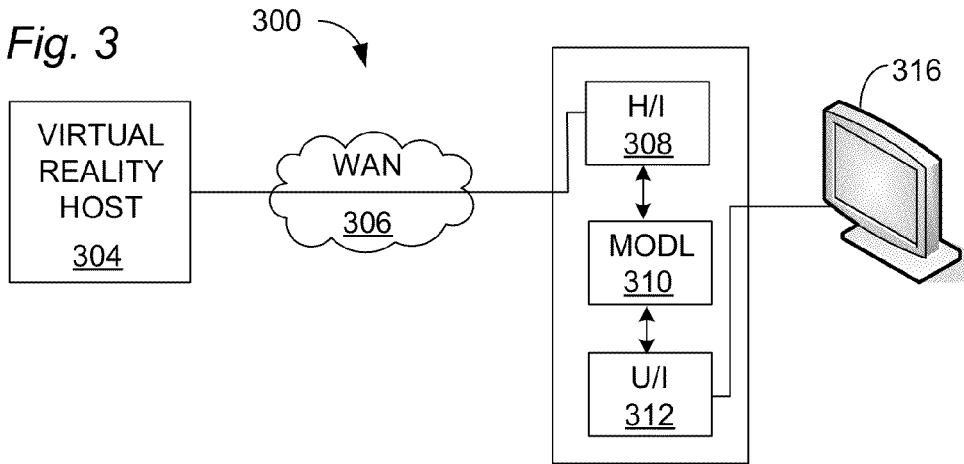

Fig. 4

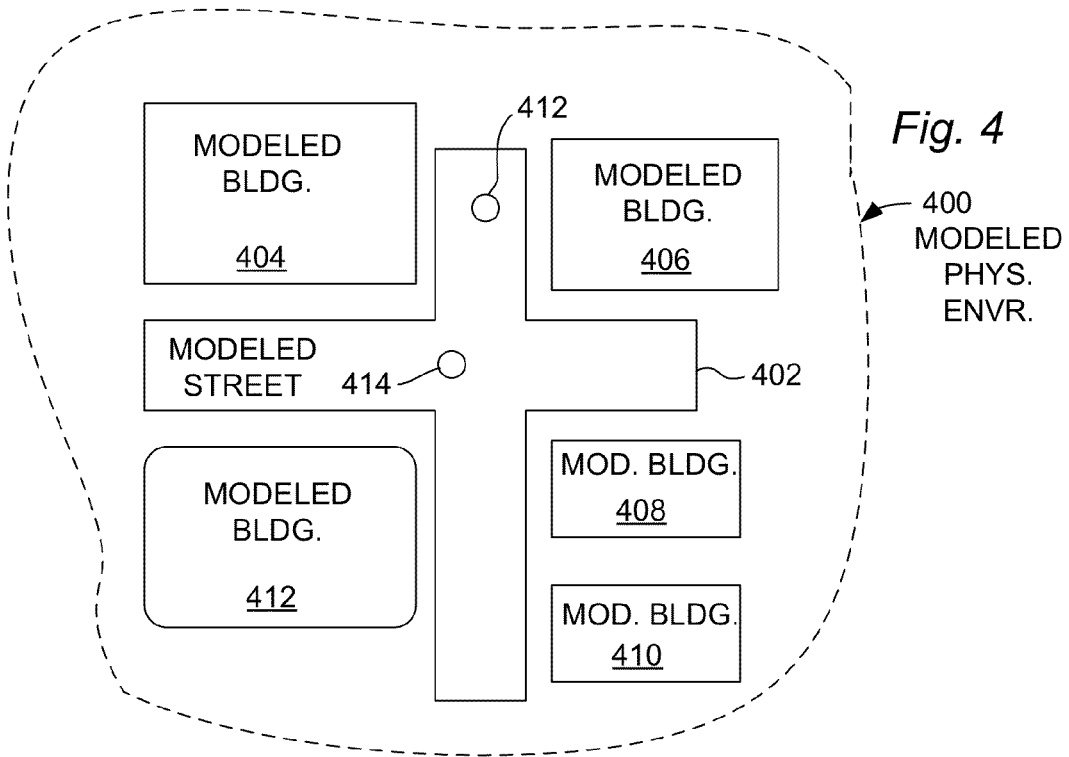
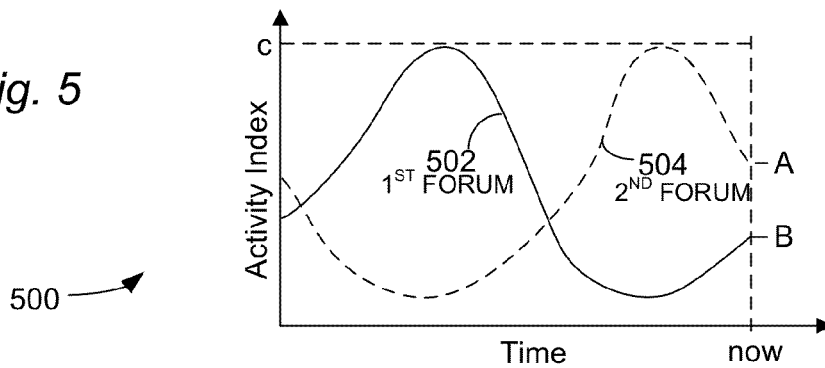

Fig. 5



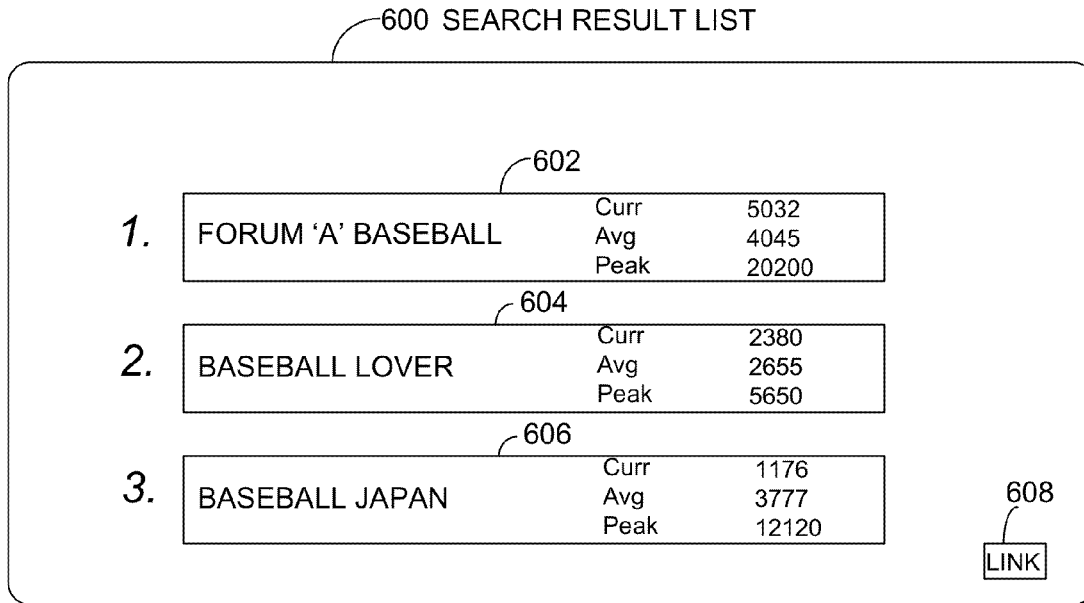

Fig. 6

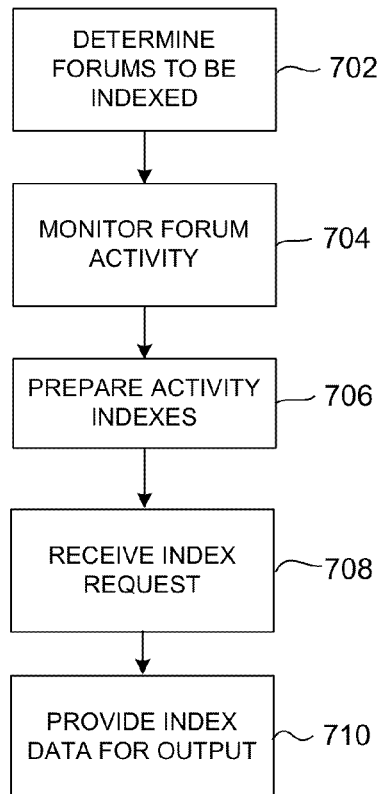

Fig. 7

700

1

## FORUM SEARCH WITH TIME-DEPENDENT ACTIVITY WEIGHTING

### CROSS-REFERENCE TO RELATED APPLICATION

This application claims priority pursuant to 35 U.S.C. § 119 (e) to U.S. provisional application Ser. No. 61/059,210, filed Jun. 5, 2008, which is hereby incorporated by reference, in its entirety.

### BACKGROUND

#### 1. Field

The present disclosure relates to methods and systems for locating information contained in disparate online forums.

#### 2. Description of Related Art

Online forums are an increasingly popular tool for exchanging current news and opinions, and for social networking. As used herein, an "online forum" is a computer-implemented system or object that receives data input transmitted from multiple clients operated by individual users, aggregates the incoming data into a forum data object having an organized display format showing the input data optionally associated with an identifier for the contributing user, and posts or transmits the forum data object in response to newly received incoming data so that the forum data object is accessible to the multiple participating clients and is continually updated with new submissions. In the forum context, to "post" means to publish in the forum. Examples of online forums include computer bulletin boards, online chat rooms, and web blogs such as are implemented using Internet technology and IP-addressed forum data objects. Further examples include proprietary technology systems that utilize dedicated client software in combination with a network host to create a social networking environment as a form of on-line game, such as, for example, Second Life™, Utherverse™, Xbox Live™ and others.

When selecting an online forum to participate in out of many possible forums of interest, users may employ a search engine to identify forums that match specified criteria. However, existing search engine technology cannot directly identify forums in which activity is currently highest, or in which activity is highest at particular times of day in a repeated pattern. Such activity information may be of interest to many users, for use in selecting forums to participate in, for use in scheduling activities to take place in forums, or both. However, present search engines do not capture or display activity information for use in comparing and selecting forums of interest. Such information is not readily apparent to existing search methods, despite its potential value. Technology to bridge this gap would be desirable.

### SUMMARY

Time-dependent activity indicia for online forum activity may be collected using an indexing server in cooperation with one or more (typically many) servers hosting various online forums. The online forum hosts are configured to receive and publish time-stamped messages or other content from numerous clients. These contributions may be organized by message thread or topic. Characteristically for forums, the time of contribution is an important organizing parameter. In many online forums, the client-contributed content is organized primarily or exclusively chronologically in the forum publications. These publications, comprising web pages or similar objects, comprise the online forums or forum

2

objects that are of interest to the end user. Activity in such forums may be defined in various different ways, but may generally be understood as a quantity of user-contributed content to the forum, per unit time. A time-dependent activity indicia refers to a measurement of activity that varies as a function of time.

The indexing server monitors activity in target forums. Target forums are selected using any suitable filter, for example average page views per day or frequency with which a forum is located using a topical search. The indexing server may use any of various methods, or a combination of such methods, to monitor and obtain relevant activity indicia for each forum. For example, the indexing server may analyze forum objects using a web crawler or similar technique, or receive activity reports from the forum host servers. The indexing server may categorize activity indicia into designated categories, for example, page views per unit time, submissions per unit time, words per unit time, and store in a database or other data structure in associate with an identifier for the each respective forum to which the activity indicia relates. The indexing server may also compute parameters such as running averages, cumulative totals, and cyclical maxima and minima for the activity data, which is also stored in the database.

The indexing server maintains the activity indicia database in a current state and provides the indicia in response to requests from search engines. The search engine may then use the activity to organize or filter search results. For example, the search engine may locate a list of forums relevant to a query search topic, request activity indicia for the listed forums from the indexing server, then rank the listed forums in order of current activity or other desired activity indicia. An end user will thereby be able to determine which forums have the greatest activity at designated times.

A more complete understanding of systems and methods for collecting and using time-dependent activity indicia of online forum activity will be afforded to those skilled in the art, as well as a realization of additional advantages and objects thereof, by a consideration of the following detailed description. Reference will be made to the appended sheets of drawings which will first be described briefly.

### BRIEF DESCRIPTION OF THE DRAWINGS

FIG. 1 is a system diagram showing an example of a networked computer system in which time-dependent activity indicia for use in forum selection may be implemented.

FIG. 2 is a block diagram illustrating an example of a system for time-dependent activity indicia for use in forum searching or selection.

FIG. 3 is a block diagram showing an alternative system for providing multiple forums to a plurality of clients via a proprietary interface.

FIG. 4 is a schematic diagram showing a partial modeled physical environment such as may be used in a virtual reality online forum.

FIG. 5 is a chart showing cyclical patterns in online activity as may be measured for online forums.

FIG. 6 is a simplified screenshot showing an example such as may be used to present forum search results ranked by order of forum activity measures.

FIG. 7 is a flowchart showing an example of a method for providing time-dependent activity indicia for use in forum searching or selection.

### DETAILED DESCRIPTION

The present technology provides a computer-implemented method or system for providing time-dependent activity indi-

3

cia for use in forum searching or selection, that overcomes the deficiencies of the prior art. The method or system may be implemented in a networked computing environment **100**, as shown in FIG. 1. An exemplary networked environment may comprise, for example, a plurality of clients **102, 104** (two of many shown) in communication via wide area network components such as Internet **106** with at least one indexing server **108**. Each client **102, 104** may comprise a processor, a input device, for example, a keyboard, pointing device, touch-screen, or microphone configured to receive input from a human user and to translate the input usable signals for the processor, and an output device, for example a display screen or speaker, to provide human-perceptible output in response to processor control. The indexing server **108** may operate one or more application to perform forum activity indexing and data output as described herein. The application may be encoded on a computer-readable medium (not shown) operably associated with the server **108**. Environment **100** may further include other servers, including but not limited to content servers, forum servers, and search engine servers (not shown), which may cooperate with the indexing server **108** to receive input from the client, develop indexing information, and output indexing information to clients **102, 104**. Various arrangements and uses of such services will become apparent to one of ordinary skill in view of the present disclosure.

FIG. 2 shows one exemplary arrangement **200** including a plurality of independent clients **202, 204, 206** communicating with a search/indexing server **208** and two independent forum servers **210, 212** via a wide area network **214**. In the illustrated example, the search/indexing server is configured to perform forum searching and indexing, receiving search requests directly from clients **202, 204, 206**, and providing activity indexing and search results directly to the clients. In an alternative embodiment, the indexing and searching functions may be distributed among two or more cooperating servers. For example, a search engine (“first”) server may provide a search engine interface and handle search requests from the independent clients. An indexing (“second”) server may perform activity indexing and provide activity indexing data to the first server in response to a data request. The first server may incorporate the index data in a search results list provided to a requesting client.

Forum servers **210, 212** (two of many shown) exemplify hosts for various independent Internet-compatible forums, for example, computer bulletin boards, web blogs, user comment pages, newsgroups, chat rooms, and so forth. Each host may receive participant contribution data from the remote clients **202**. “Participant contribution data” as used herein refers to text, image, video, and/or audio data originating from a client participating in a online forum and designated for publication as a user posting/contribution in that forum. The forum host organizes the incoming participant contribution data according to the forum’s organizing principles and publishes a forum web page **214, 216** or other object that provides access to the participant contribution data to forum members or participants. Optionally, the forum host filters, edits, or removes defective or objectionable participant contribution data before or after it is published in the forum. The forum page or other published object may be refreshed in response to participant contribution data as it is newly received by each respective forum server, at periodic intervals, in response to requests for the forum data, or any combination of the foregoing. In the alternative, the participant contribution data may be placed in a forum database as it is received and processed by the forum server, where it becomes available via a database interface page. Other suitable methods of hosting an online forum may also be known. Whatever

4

method is used, the hosted forum objects (for example, forum pages **214, 216**) have the characteristic of continuously changing in response to the addition of new participant contribution data. The more active the forum, the more quickly the forum object may change.

Rapidly changing data objects present a challenge to traditional search engines in that frequent refreshing of the search index is required to maintain search accuracy. This may be dealt with in various ways, such as by identifying data objects that change frequent as candidates for being considered forum objects, and scheduling known forum objects for more frequent indexing. Such solutions, however, are merely ancillary to the objectives and methods of the present disclosure. A different problem is faced by a user that seeks to optimize a forum selection process, or the timing of a forum event. One such problem is to identify, out of any given set of forums, which forums have the greatest relative activity. Another such problem is to determine, again for any given selection of forums, what relative level of activity may be expected in each forum at a particular time, or when a desired relative level of activity is most likely to occur. For example, a prospective forum participant may desire to select, out of a group of forums identified with the topic of “U.S. National Politics,” that forum or forums with the highest current level of activity. For further example, a forum participant may desire to know what time of day a certain designated forum has historically experienced the greatest average level of activity.

Forum “activity” as used herein should be distinguished from inherent external characteristics of the forum data object, such as the most recent refresh time or a number of refreshes in a particular time period. Activity does not refer to such characteristics that are mere consequences of forum management by a forum host. Instead, forum activity refers to any one or combination of the following factors (a) the number of clients (or of clients having designated characteristics) requesting access to or viewing the forum object at a particular instant of time or within a designated limited time period (for example, the most recent second, minute, hour, day, etc.); (b) the rate at which participant contribution data (however measured) is being received for posting or is posted in a forum, again within any useful designated time period, for example, new posts per minute or words per minute; (c) a rate of change of (a) or (b); or (d) a quality of data received per unit time, for example, the number of 5-star rated postings received in the last 24 hours, wherein star ratings are published by the forum in response to user feedback.

As defined above, activity constitutes a machine-measurable state directly associated with the computer-implemented forum object, attributable to data submissions from participating clients. Generally, forum activity may be most easily measured directly at each forum host, for example at hosts **210, 212**, although the technology is not limited to this. Each forum host may execute, as part of its hosting process, an application or object that measures and records forum activity on a time-indexed basis. In the alternative, or in addition, the forum page or other object may be periodically processed by an application that is external to the forum host to measure forum activity that is discernable from information published in the forum object. It should be appreciated that “forum object” may include multiple linked Web pages or similar linked network objects that as a group make up a discrete forum.

Search/indexing server **208** may therefore receive forum activity data from various forum servers or hosts by any suitable method. For example, server **208** may maintain a database that is updated in response to receiving periodic data

5

updates from remote forum hosts, according to a predetermined data sharing arrangement. In the alternative, or in addition, the server **208** may query one or more particular forum hosts for an update of forum activity data at periodic intervals, or in response to a search request from a system client. In yet another alternative or addition, the server **208** may access the forum data object (for example, pages **214**, **216**) and measure the forum activity such as can be discerned from the object itself. Some types of activity, for example the number of clients requesting access to the object, may not be discernable from inspection of the published forum object. Other activity, for example the number of postings in a defined time period, may be discernable from such inspection.

The search indexing server **208** may process activity data to develop one or more numerical indicators of forum activity level. The server **208** may store the indicators in a database or data table in association with an identifier for each forum and each time, or time period, to which the indicators pertain. In the alternative, or in addition, server **208** may calculate relevant activity indicators on the fly, in response to a data request. Server **208** may provide requested activity indicators in response to requirements from an internal search query or remote client request. For example, server **208** may receive a query from client **202**, requesting “top five most currently active forums concerning baseball.” In response, server **208** may first perform a search to identify all forums concerning baseball. Then, the server may query an activity index database to determine a most current activity indicator for each baseball forum. The server may then rank all the baseball forums in order of the returned activity indicator, and return a list of the top five most active baseball forums, rank ordered by activity indicator, to the requesting client **202**.

FIG. 3 shows an alternative system **300** for providing multiple forums to a plurality of clients **302** (one of many shown) via a proprietary interface, for example, in a massively multi-user online virtual reality system for social networking or gaming. System **300** may also include a virtual reality host **304** which may communicate with the plurality of clients via a wide area network **306**. Host **304** may provide state data regarding a multiuser (i.e., process in which multiple clients participate simultaneously) to each participating client, for example client **302**. Each client may cooperatively operate a host interface process **308**, a modeling process **310**, and a user interface process **312** within a virtual reality client application **314**. The client application **314** may receive user input data and provide it to the host process **304**. The host **304** aggregates multiple client input data, which may include participant contribution data for any forums hosted as part of, or associated with, the virtual reality process, to continuously provide state data for a modeled virtual reality process and associated forums. The host may provide the state data to the client VR process **314**, which provides an output of the modeled environment as it changes through time and forum data, for example providing a visual display on monitor **316**.

The virtual reality host may model a virtual physical environment through which each client may navigate via an associated avatar. FIG. 4 shows a schematic diagram of a partial modeled physical environment **400**, in plan view. The exemplary model includes a modeled city street **402**, along which are placed various modeled building **404**, **406**, **408**, **410** and **412**. Any number of avatars, for example avatars **412**, **414**, may be modeled in response to client input or system input within the modeled environment **400**. One of the functions of the virtual reality environment is to provide an intuitive and visually stimulating navigational interface for all sorts of online activities, including participation in various forums.

6

For example, environment **400** may include a first building **408** given the appearance of a singles’ bar and intended to attract clients interested in a forum for meeting like-minded singles. To participate in the singles forum, the client may move a client-controlled avatar inside the “singles bar” **408**. Once “inside” the bar **408**, the client may automatically participate in a chat session with other clients that also have avatars within the “bar” or be given an option to do so. Other modeled buildings may provide access of different sorts of forums.

Despite a different user interface and architecture, the virtual reality environment **400** may host essentially the same types of forums as are executed in World Wide Web environments. One difference is that, currently, no uniform standard exists for hosting virtual reality processes. Therefore, all VR activity, including forum activity, is generally controlled through a unified proprietary host process. As such, searching for forums, indexing forum activity, and reporting on forum activity as described for World Wide Web processes may occur as part of the host process, instead of via cooperation between external host, search, and indexing servers. However, user of a VR process does not preclude external forum hosting or searching, as computing bridges may be built to link a proprietary VR process with external forum processes, search engines, or other services. FIGS. 3 and 4 are merely intended to illustrate how the inventive concepts herein may be applied in contexts other than the World Wide Web.

For example, within a virtual reality process with a large number of subscribing clients it is not unthinkable that dozens or even hundreds of alternative forums may be available at any given time. Navigating to numerous ones of these forums to find one in which suitable activity is occurring, and at which times, may be tedious for subscribing clients. Therefore, a VR host may offer a forum search function by which a client may search available forums to quickly locate one of more forums in which the desired level of activity is occurring, or reporting on one or more activity measures over daily/weekly/monthly or other periods. The client may then navigate an avatar to one of those forums to participate in the forum activities, or discern activity patterns in the various forums.

In general, an indexing host, whether for general or proprietary forums, may determine and record an activity index over time, resulting in index data that may be plotted against time to reveal periodic activity patterns. For example, FIG. 5 shows an exemplary comparative plot **500** comparing the activity of two different forums over time. The highest current level of activity ‘A’ in a first forum is evident from the dashed indicator line **502** for the first forum, although activity is declining. A lower level of activity ‘B’ in a second forum is evident from the solid indicator line **504**, although activity is increasing. Both the first and second forums have approximately the same peak level ‘C’ in the chosen activity index over the past reporting period. The sinusoidal pattern of the indicator lines may indicate, for example, a diurnal variation caused by differences in the geographic location of forum participants. Such patterns may be of interest, for example, to persons looking for a forum with a particular geographic predominance in the participants, or for other reasons.

FIG. 6 shows an exemplary search result list **600** such as may be returned by a search/indexing process in response to a client query, and output on a client display. Each item **602**, **604**, **606** on the list may comprise an entry for a forum concerning a topic specified by the query, for example “baseball.” Each entry may comprise a description of the forum and/or a hyperlink to it, or other address. To the right of the description, several numeric activity indicators are listed for

each entry, in this example, a most current activity level relative to the time the query was received, an average level over the past reporting period (for example, past day, week, or month), and a peak level over the past reporting period. Numeric indicator values may, in the alternative or in addition, be displayed List 600 may further include a link 608 to a chart showing a comparative activity indicator over time, as shown in FIG. 5.

FIG. 7 is a diagram showing exemplary steps of a method 700 such as may be performed by an indexing host application or server to provide time-dependent activity indicia for use in forum searching or selection. Instructions for performing the illustrated steps may be encoded in a computer-readable media for causing a host computer to perform the method, using methods as known in the art.

At 702, the host may determine which forums are to be indexed, that is, identifying the forums for which at least one activity index will be measured and tracked. In an embodiment, the host may identify all known forums, wherein known forums are identified by the host using a web crawler or other software that scans the Internet to discover published forum objects. In the alternative, or in addition, the host may identify forums that are located in response to user search queries. This approach may be appropriate where the indexing host provides activity index data to an external search engine operating a client interface. It has the advantage of limiting the forums that are indexed to forums that are actually found in response to user queries, therefore preventing wasting indexing resources on forum in which there is no apparent user interest. Conversely, because new forums of interest cannot be predicted, the host will not possess historical activity index data for forums that are requested for the first time. The host may cease indexing forums some time after (for example, weeks, months, or years) the last apparent user interest in the forum. Another approach is to limit indexed forums to those hosted by the indexing host, or by one or more specific forum hosts cooperatively associated with the indexing host. This approach may be suitable for indexing proprietary forums such as operated via multiuser online virtual reality hosts. Yet another approach is to develop activity indexes in response to specific user requests. For example, forum operators or users may register a particular forum for indexing by the host. In general, the set of indexed forums should not be static and should change over time to reflect forums having a pattern of recent activity or interest. Such forums may be identified in a list or database maintained by the indexing host.

At periodic intervals, the host may monitor forum activity 704 in the identified forums. As previously described, activity may be tracked by the forum host and reported to the indexing host. For example, a monitoring application may be distributed from the indexing host and operate on participating forums to monitor and report activity data to the indexing host. In the alternative, or in addition, the indexing host may operate web crawling software or other means for scanning published forum data to measure levels of current and past activity. For example, many forums publish member statistics and current forum viewing statistics on the forum pages. Web crawling software may be used to collect these statistics for use in activity indexing. For further example, the web crawling software may analyze forum objects to quantify past activity by a number of posted messages and time of posting of each message on the forum.

The indexing host may continually collect activity measurements and prepare activity indexes 706 from the provided data. As previously described, activity indexes are numerical indicators of (a) the number of clients (or of clients having

designated characteristics) requesting access to or viewing the forum object at a particular instant of time or within a designated limited time period (for example, the most recent second, minute, hour, day, etc.); (b) the rate at which participant contribution data (however measured) is being received for posting or is posted in a forum, again within any useful designated time period, for example, new posts per minute or words per minute; (c) a rate of change of (a) or (b); or (d) a quality of data received per unit time. For example, the number of current viewers may be measured in five-minute intervals, and this number stored to provide a historical pattern of activity, including derivative indicators such as moving averages or the like.

At 708, the indexing host may receive requests for indexing data. These may occur, for example, as part of a search engine process that identifies forums in response to user queries. For example, a search engine may request specified index data for all results appearing on a search results list. In general, the indexing host may operate as a general data service configured to provide various different indexing data responsive to internal or external data requests.

At 710, the indexing host may retrieve and/or generate the requested indexing data in response to an incoming data request, configured for eventual output on the requesting client, for example in a screen as shown in FIG. 6. The responsive indexing data may be output in a format for display directly by the indexing host, or formatted by an intermediary client such as a search engine host before transmission to the end user client. The search engine may use the reported activity indices for each forum to prioritize or filter search reports reported to a search engine client.

Method 700 merely exemplifies a method for providing time-dependent activity indicia for use in forum searching or selection. The present technology is not limited by this example.

Having thus described a preferred embodiment of forum searching using time-dependent activity weighting, it should be apparent to those skilled in the art that certain advantages of the within system have been achieved. It should also be appreciated that various modifications, adaptations, and alternative embodiments thereof may be made without departing from the scope and spirit of the present technology. The following claims define the scope of what is claimed.

The invention claimed is:

1. A method comprising:
  - monitoring, using a computer, forum activity in a selected group of online forums accessible over a computer network, wherein the forum activity is defined based on an aggregate of user-contributed content by all clients participating in the online forums;
  - generating an index of forum activity measurements comprising activity measures for each of the online forums, using the computer, wherein the forum activity measurements indicate measures of the forum activity per unit of time for different past time periods;
  - receiving a data request for the forum activity measurements pertaining to one or more online forums included in the group of online forums from the index; and
  - serving the forum activity measurements from the index in response to the data request.
2. The method of claim 1, further comprising identifying online forums for inclusion in the group of online forums.
3. The method of claim 1, wherein generating the index further comprises computing the forum activity measurements comprising counts of clients requesting access to each of the group of online forums within the respective different time periods.



4. The method of claim 3, wherein generating the index further comprises computing the forum activity measurements comprising a rates of change in the counts of clients requesting access to each of the group of online forums within a the respective different time periods.

5. The method of claim 1, wherein generating the index further comprises computing the forum activity measurements comprising rates per unit time at which participant contribution data is posted to each of the group of online forums within a the respective different time periods.

6. The method of claim 5, wherein generating the index further comprises computing the forum activity measurements comprising a rate of change in the rates at which participant contribution data is posted to each of the group of online forums within a designated time period.

7. The method of claim 1, wherein generating the index further comprises computing the forum activity measurements comprising a quality of data received per unit time.

8. The method of claim 1, wherein the computer monitors the forum activity at periodic intervals.

9. The method of claim 1, wherein the computer monitors the forum activity in cooperation with monitoring applications distributed from the computer to computer hosts for the group of monitoring applications.

10. The method of claim 1, wherein the computer monitors the forum activity by scanning published forum data from the group of online forums.

11. The method of claim 1, wherein the computer monitors the forum activity by processing forum objects to quantify past activity by number of posted messages during past time periods.

12. A system comprising:

a search engine implemented in a computer processor and memory, configured for serving a search engine interface and handling search requests from clients;

an activity index application implemented in a processor and memory operatively associated with the search engine, and configured to provide measures of forum activity in response to requests from the search engine, wherein the measures of forum activity quantify the forum activity per unit of time for different past time periods caused by contributions from a plurality of clients participating in one or more online forums identified by the requests from the search engine, and wherein the forum activity is defined based on an aggregate of user-contributed content by all clients participating in the one or more online forums.

13. The system of claim 12, wherein the search engine is further configured to rank search results responsive to searches for online forums according to the measures of

forum activity per unit of time for respective different time periods in a past period of time from the activity index application.

14. The system of claim 12, further comprising an activity monitoring application implemented in a processor and memory operatively associated with the activity index application, and configured to monitor the forum activity per unit of time for respective different time periods in a past period of time in the one or more online forums.

15. The system of claim 12, wherein the search engine application is further configured to rank search results responsive to the search requests in order of the measures of forum activity per unit of time for respective different time periods in a past period of time provided by the activity index application.

16. The system of claim 15, wherein the measures of forum activity comprise a measure of activity occurring in a most recent time period.

17. The system of claim 15, wherein the measures of forum activity comprise a measure of activity occurring at a specific recurring time period selected from a time of day, or a day of a weekly cycle.

18. A non-transitory computer-readable medium encoded with instructions configured, when executed by a computer processor, to cause the computer to:

measure forum activity in online forums accessible over a computer network, wherein the forum activity is defined based on an aggregate of user-contributed content by all clients posting messages to the online forums;

maintain forum activity measurements indicating the forum activity in a database per unit of time for different past time periods in association with identifiers for respective ones of the online forums;

respond to requests for the forum activity measurements pertaining to specified ones of online forums at a specified time by providing the forum activity measurements associated with the specified online forums and specified times from the database.

19. The non-transitory computer-readable medium of claim 18, further comprising instructions configured, when executed by a computer processor, to cause the computer to calculate the forum activity measurements indicating average forum activity at cyclically recurring time periods as a measure of forum activity maintained in the database.

20. The non-transitory computer-readable medium of claim 19, further comprising instructions configured, when executed by a computer processor, to cause the computer to determine one or more cyclically recurring time periods for each online forum during which average forum activity achieves a maximum value.

\* \* \* \* \*